

# Analysis Performance of Cell Free Massive 32×32 MIMO Systems with QR-RLS Technique

Ashish Ashok Kumar

Department of Electronics and Communication, OCT, Bhopal, India

**ABSTRACT:** The fifth generation of mobile communication systems (5G) promises unprecedented levels of connectivity and quality of service (QoS) to satisfy the incessant growth in the number of mobile smart devices and the huge increase in data demand. One of the primary ways 5G network technology will be accomplished is through network densification, namely increasing the number of antennas per site and deploying smaller and smaller cells. Massive MIMO, where MIMO stands for multiple-input multiple-output, is widely expected to be a key enabler of 5G. This technology leverages an aggressive spatial multiplexing, from using a large number of transmitting/receiving antennas, to multiply the capacity of a wireless channel. Cell-free massive MIMO refers to a massive MIMO system where the BS antennas, herein referred to as access points (APs), are geographically spread out. The APs are connected, through a fronthaul network, to a central processing unit (CPU) which is responsible for coordinating the coherent joint transmission. Such a distributed architecture provides additional macro-diversity, and the co-processing at multiple APs entirely suppresses the inter-cell interference. Depending on slow/fast channel fading conditions, several authors suggested adaptive LMS, RLS and NLMS based channel estimators, which either require statistical information of the channel or are not efficient enough in terms of performance or computations. In order to overcome the above effects, the work focuses on the QR-RLS based channel estimation method for cell free Massive MIMO systems.

**KEYWORDS:** Massive MIMO, Channel State Information, Square Root-Recursive Least Square (QR-RLS)

## I. INTRODUCTION

The radio stripe system, described earlier, represents a cost-efficient build practice of a ubiquitous “cell-free” Massive MIMO system. Furthermore, it might be an ideal solution in terms of flexibility and scalability of the deployment, and to provide coverage to environments where large and visible installations, typical of centralized network architectures, are not admissible either because of regulation or space constraints. In this regard, we next analyze the performance provided by a radio-stripe system in two case studies of practical interest: (i) industrial indoor scenario, and (ii) piazza scenario (outdoor) [1].

Nowadays, wireless communication plays a central role in the industrial production process. Ubiquitous coverage, low latency, ultra-reliable communication, and resilience are key for wireless communications in a factory environment. In this respect, “cell-free” Massive MIMO, with its flexible distributed architecture, with its macro-diversity gain and inherent ability to suppress interference, is suitable to cope with the challenging industrial indoor scenario [2]. Also, a radio stripe deployment may integrate additional sensors/actuators such as temperature sensors, microphones, miniature speakers, vibration sensors, etc., and provide additional important features, e.g., fire alarm, burglar alarm, earthquake warning, indoor positioning, climate monitoring and control.

### Cell Free Massive MIMO

It also has the capacity to overcome many of the disadvantages of massive MIMO. Cell free massive MIMO also tells us about many advantages such as [3] its huge throughputs, Its high coverage probability along with the micro-diversity gain, small scale fading or its capability to control the average uncorrelated noise cell free massive MIMO can only be deviated by large scale fading [4].

It is very clear that performance of cell free massive MIMO is better than small cell system. It provides almost 20 folds and 95% likely per users throughputs [5]. Distributed APs are connected with CPU by a high backhaul capacity link in cell free massive MIMO.

While the problems arise due to limited backhaul link are considered in [5] and so also we have analyzed the hindrances caused by zero forcing reading designing in paper [6].

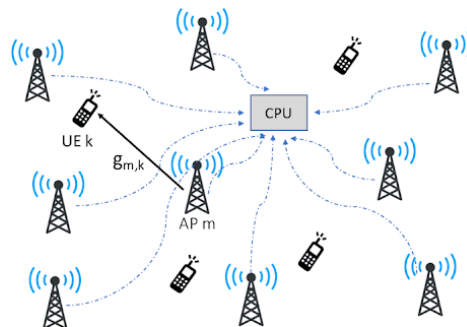

Figure 1: Cell free massive MIMO system

## II. CHANNEL ESTIMATION

In order to achieve the benefits of a large antenna array, accurate and timely acquisition of Channel State Information (CSI) is needed at the BS. The need for CSI is to process the received signal at BS as well as to design a precoder for optimal selection of a group of users who are served on the same time-frequency resources. The acquisition of CSI at the BS can be done either through feedback or channel reciprocity schemes based on Time Division Duplex (TDD) or Frequency Division Duplex (FDD) system. The procedure for acquiring CSI and data transmission for both systems is explained in the subsequent sections.

### Channel Estimation and Data Transmission in TDD System

In TDD system, the signals are transmitted in the same frequency band for both uplink and downlink transmissions but at different time slots. Hence, uplink and downlink channels are reciprocal. During uplink transmission, all the users in the cell synchronously send the pilot signal to the BS. The antenna array receives the modified pilot signal by the propagation channel. Based on the received pilot signal, BS estimate the CSI and further, this information is used to separate the signal and detect the signal transmitted by the users as shown in Fig 2. In downlink transmission, due to channel reciprocity, BS uses the estimated CSI to generate precoding/beamforming vector. The data for each user is beam formed by the precoded vector at the BS and transmitted to the user through propagation channel as shown in Fig 4.

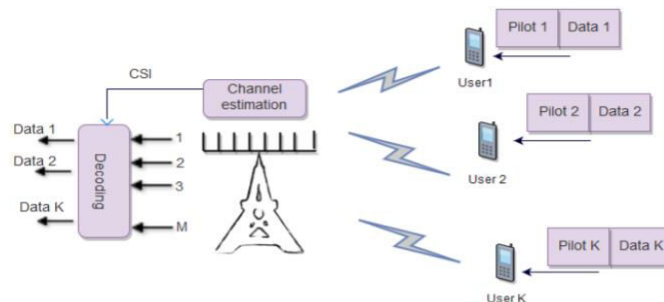

Figure 2: Uplink transmission in a TDD Massive MIMO system

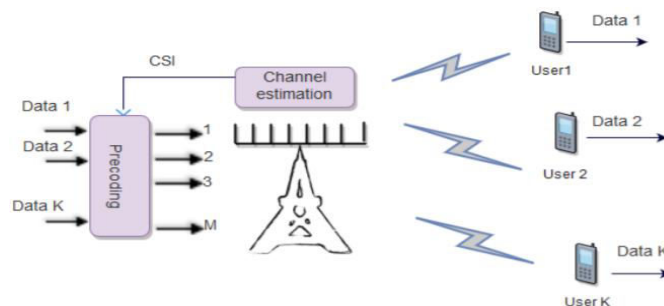

Figure 3: Downlink transmission in a TDD Massive MIMO system

**Channel Estimation and Data Transmission in FDD System**

In FDD system, the signals are transmitted at different frequency band for uplink and downlink transmission. Therefore, CSI for the uplink and downlink channels are not reciprocal. Hence, to generate precoding/beamforming vector for each user, BS transmits a pilot signal to all users in the cell and then all users feedback estimated CSI of the downlink channels to the BS as shown in Fig. 4. During uplink transmission, BS needs CSI to decode the signal transmitted by the users. To detect the signal transmitted by the user, CSI is acquired by sending pilot signal in the uplink transmission.

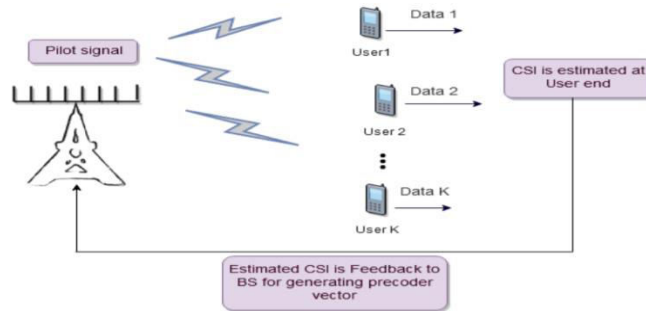

Figure 4: Downlink transmission in an FDD Massive MIMO system

**III. PROPOSED METHODOLOGY**

The MIMO-OFDM device modified into applied with the useful resource of MATLAB/SIMULINK. The execution device is binary facts this is modulated the use of QAM and mapped into the constellation elements.

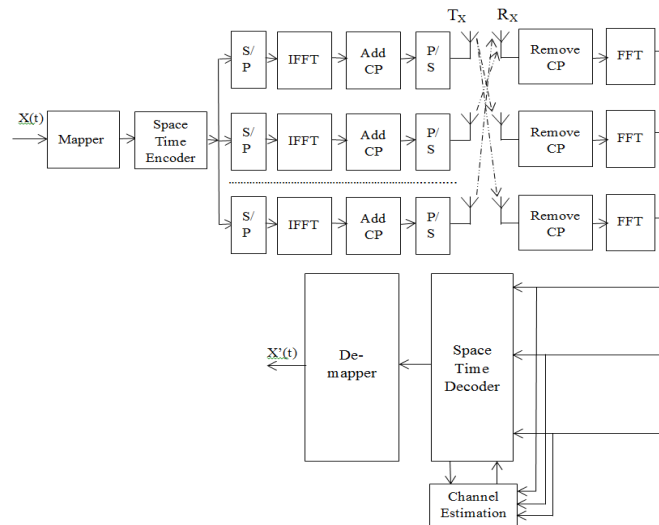

Figure 5: Massive MIMO System Models with Channel Estimation Technique

The virtual modulation scheme will transmit the records in parallel by means of manner of assigning symbols to every sub channel and the modulation scheme will determine the phase mapping of sub-channels thru a complex I-Q mapping vector show in figure 5. The complicated parallel facts stream must be converted into an analogue signal this is suitable to the transmission channel.

The complicated parallel facts stream has to be transformed into an analogue sign that is suitable to the transmission channel. It is performed to the cyclic prefix add to the baseband modulation signal because the baseband signal is not overlap. After than the signal is splitter the two or more part according to the requirement.

**Square Root Recursive Least Square (QR-RLS) Algorithm**

A QR-RLS based MIMO-OFDM channel estimation is proposed. Which uses givens rotation based QR factorization for estimator updating. Channel estimation is a center issue for recipient plan in remote correspondences frameworks. Since it is unimaginable to expect to quantify each remote direct in the field, it is critical to utilize preparing arrangements to appraise channel parameters, for example, constrictions and deferrals of the proliferation way. Since in

most UWB recipients associate the got flag with corresponded a predefined format flag, an earlier learning of the remote channel parameters is important to foresee the state of the layout flag that matches the got flag.

**Mathematical Equation**

Be that as it may, because of the wide data transfer capacity and diminished flag vitality, UWB beats experience extreme heartbeat twisting.

Consider the received signal at q<sup>th</sup> receive antenna represented in matrix form as

$$Y(n) = (U(n).H(n)) + V(n) \tag{1}$$

The posteriori error is given by the difference between the received preamble symbol and its corresponding estimate at time n on q<sup>th</sup> receiving antenna

$$e(q, n) = y(q, n) - \tilde{y}(q, n) \tag{2}$$

$$e(q, n) = y(q, n) - X_{pre}(n)\tilde{H}_q \tag{3}$$

Where  $\tilde{H}$  has the same dimensionality as H. The weighted Square-root error at time n is given by

$$e(q, n) = \sum_{i=0}^n \lambda^{n-i} (|e(q, i)|)^2 \tag{4}$$

Where  $\lambda$  is weigh factor, whose value lies between (0, 1) depending on channel fading conditions is present. Solution of the above equation gives the optimum value for the estimated channel coefficients H at time n. The optimum solution

$$H_q(n) = R^{-1}_X(n) \times R_{YqX}(n) \tag{5}$$

Where  $R^{-1}_X(n)$  is the autocorrelation matrix of the preamble signal, is the cross correlation matrix between received signal and the preamble signal at time n.

**IV. SIMULATION RESULT**

Simulation experiments are conducted to evaluate the SNR VS Bit Error Rate (BER) performance of the proposed algorithm 8x8 system is shown in figure 6.

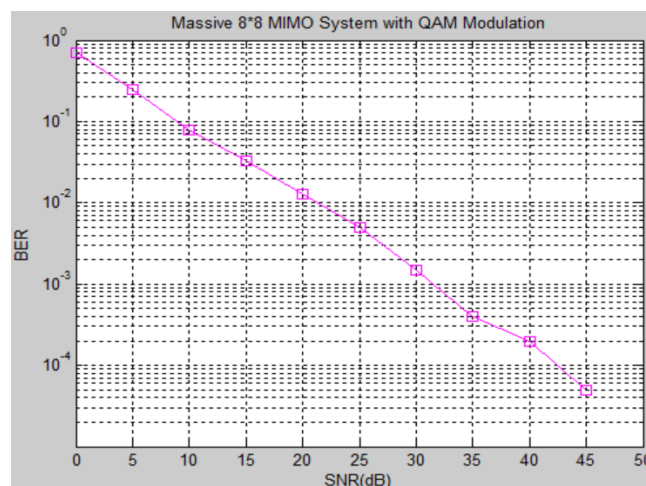

Figure 6: BER vs SNR for Cell free Massive 8x8 System with QR-RLS based Channel Estimation Technique

Simulation experiments are conducted to evaluate the SNR VS BER performance of the proposed algorithm 16x16 system is shown in figure 7.

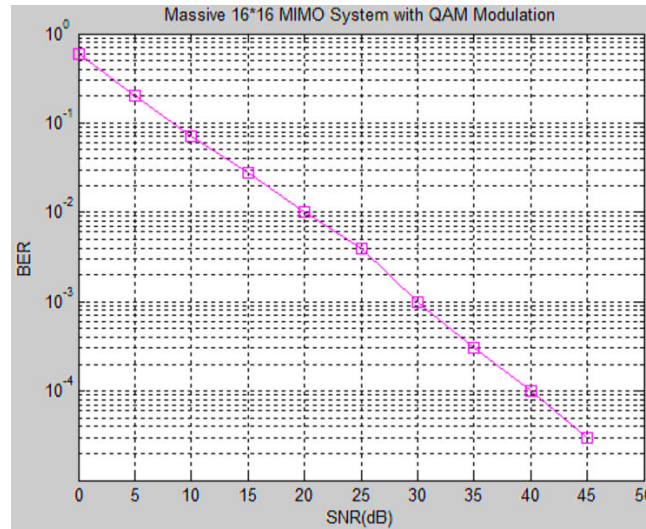

Figure 7: BER vs SNR for Cell free Massive 16x16 System with QR-RLS based Channel Estimation Technique

Simulation experiments are conducted to evaluate the SNR VS BER performance of the proposed algorithm 32x32 system is shown in figure 8.

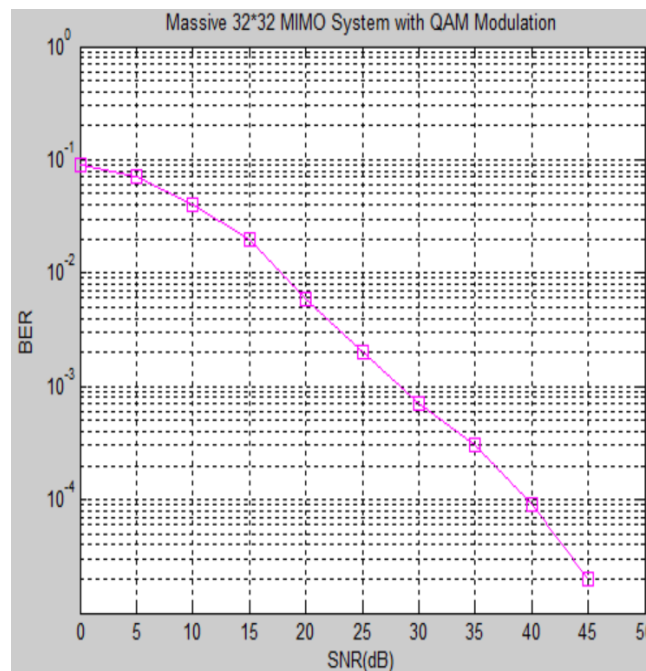

Figure 8: BER vs SNR for Cell free Massive 32x32 System with QR-RLS based Channel Estimation Technique

Simulation experiments are conducted to evaluate the SNR VS spectrum efficiency performance of the proposed algorithm 32x32 system is shown in figure 8.



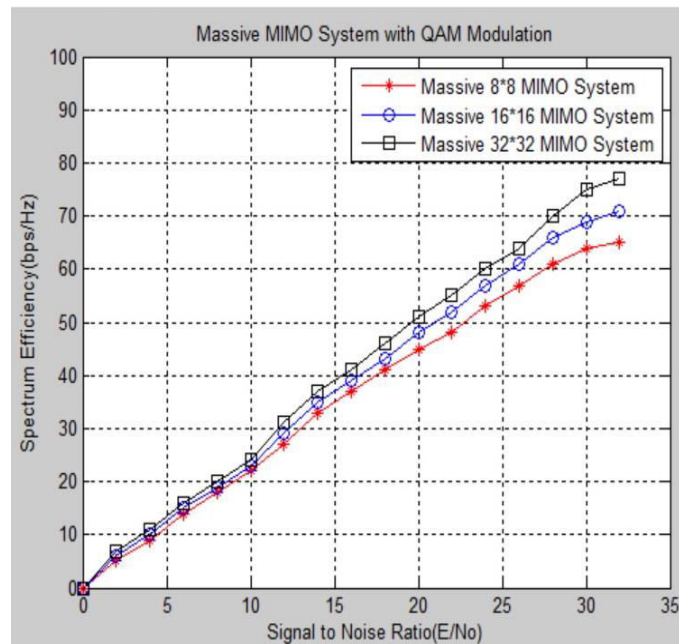

Figure 9: Spectrum Efficiency vs SNR for Cell free Massive 8x8 System with QR-RLS based Channel Estimation Technique

## V. CONCLUSION

Cell-free massive MIMO is a relatively new topic. It is plenty of directions to exploit for future work. QR-RLS channel estimation methods, to let the users estimate the downlink channel from the data symbols, need to be investigated to give the final answer whether we can do without the downlink pilots in cell-free massive MIMO. This paper has dealt with channel estimation for single cell Massive MIMO system with no interference from other cells. However, it is necessary to estimate the channel of a single cell, when the signal from other cells interferes with the signal of the desired cell. Consider the case, where BS estimates not only the channel parameters of desired links in a given cell but also, those of the interference links from adjacent cells. In multi-cell case, it is necessary to study the interference links, in order to have interference coordination. Therefore, the analysis presented in this work can be extended to a multi-cell scenario.

## REFERENCES

- [1] H. Q. Ngo A. Ashikhmin H. Yang E. G. Larsson T. L. Marzetta "Cell-free massive MIMO versus small cells" IEEE Trans. Wireless Commun. vol. 16 no. 3 pp. 1834-1850 Mar. 2017.
- [2] Huang A. Burr "Compute-and-forward in cell-free massive MIMO: Great performance with low backhaul load" Proc. IEEE Int. Conf. Commun. (ICC) pp. 601-606 May 2017.
- [3] Q. Huang A. Burr "Compute-and-forward in cell-free massive MIMO: Great performance with low backhaul load" Proc. IEEE Int. Conf. Commun. (ICC) pp. 601-606 May 2017.
- [4] H. Q. Ngo A. Ashikhmin H. Yang E. G. Larsson T. L. Marzetta "Cell-free massive MIMO: Uniformly great service for everyone" Proc. IEEE Int. Workshop Signal Process. Adv. Wireless Commun. (SPAWC) pp. 201-205 Jun. 2015
- [5] E. Nayebe A. Ashikhmin T. L. Marzetta H. Yang "Cell-free massive MIMO systems" Proc. 49th Asilomar Conf. Signals Syst. Comput. pp. 695-699 Nov. 2015.
- [6] F. Rusek, D. Persson, B. K. Lau, E. G. Larsson, T. L. Marzetta, O. Edfors, and F. Tufvesson, "Scaling up mimo: Opportunities and challenges with very large arrays," IEEE Signal Process. Mag., vol. 30, no. 1, pp. 40-60, Jan 2013.
- [7] L. Lu, G. Y. Li, A. L. Swindlehurst, A. Ashikhmin, and R. Zhang, "An overview of massive MIMO: Benefits and challenges," IEEE J. Sel. Topics Signal Process., vol. 8, no. 5, pp. 742-758, Oct 2014.
- [8] S. Payami and F. Tufvesson, "Channel measurements and analysis for very large array systems at 2.6 ghz," Proc. 6th Eur. Conf. on Antennas and Propag. (EUCAP), pp. 433-437, March 2012.
- [9] A. F. Molisch, V. V. Ratnam, S. Han, Z. Li, S. L. H. Nguyen, L. Li, and K. Haneda, "Hybrid beamforming for massive MIMO: A survey," IEEE Comm. Mag., vol. 55, no. 9, pp. 134-141, 2017.



- [10] F. Sohrabi and W. Yu, "Hybrid digital and analog beamforming design for large-scale antenna arrays," *IEEE Journal of Selected Topics in Signal Processing*, vol. 10, no. 3, pp. 501–513, April 2016.
- [11] O. E. Ayach, S. Rajagopal, S. Abu-Surra, Z. Pi, and R. W. Heath, "Spatially sparse precoding in millimeter wave MIMO systems," *IEEE Transactions on Wireless Communications*, vol. 13, no. 3, pp. 1499–1513, March 2014.
- [12] I. Ahmed, H. Khammari, A. Shahid, A. Musa, K. S. Kim, E. D. Poorter, and I. Moerman, "A survey on hybrid beamforming techniques in 5G: Architecture and system model perspectives," *IEEE Communications Surveys and Tutorials*, vol. 20, no. 4, pp. 3060–3097, Fourthquarter 2018.
- [13] S. Payami, N. Mysore Balasubramanya, C. Masouros, and M. Sellathurai, "Phase shifters versus switches: An energy efficiency perspective on hybrid beamforming," *IEEE Wireless Communications Letters*, vol. 8, no. 1, pp. 13–16, Feb
- [14] Akhilesh Venkatasubramanian, Krithika.V and Partibane. B, "Channel Estimation For A Multi-User MIMOOFDM- IDMA System", *International Conference on Communication and Signal Processing*, April 6-8, 2017, India.